

Data Sheet



Article number: 021816011200

Description: Clamp with bracket and rubber
SPGU 6011. 200/30 SK

Measures

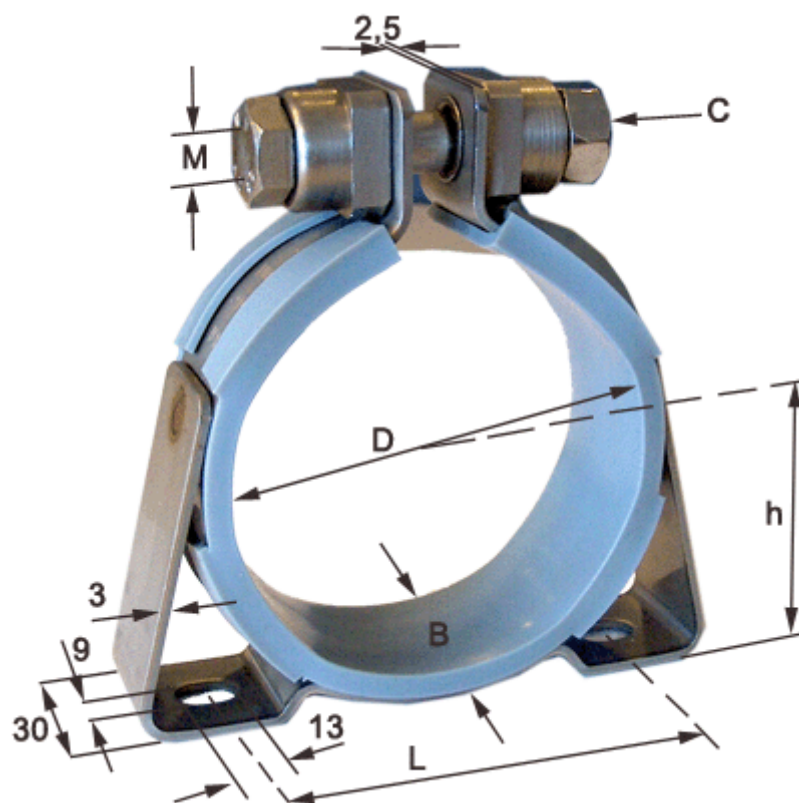

C (screw type) = SK hexagon screw

Diameter D = 200

h = 108

L = 212

Width B = 30